

# Plasticus

BY MICROLIT

## PLASTICWARE & TISSUE CULTURE CONSUMABLES

2024

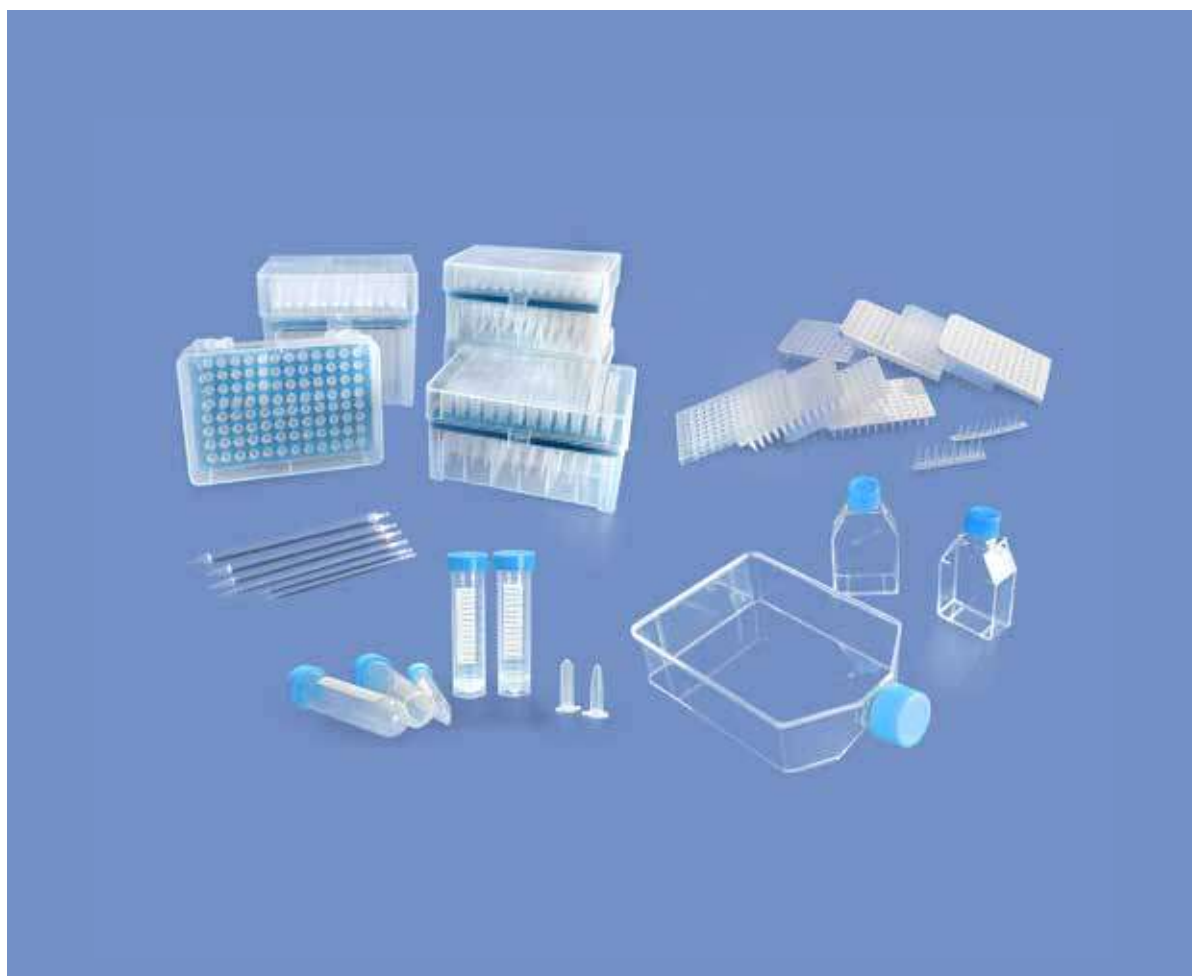

Engineered with **Accuracy**



Microlit, a globally renowned leader in laboratory equipment and precision liquid handling solutions, has long been at the **forefront of innovation**. With a rich history of pioneering advancements in pipettes, dispensers and other laboratory instruments, Microlit has consistently pushed the boundaries of scientific excellence with **8000+ customers** in **95+ countries**. Drawing upon decades of expertise and a deep understanding of the needs and challenges faced by researchers and technicians, we identified a critical gap in the market - **the need for high-quality, reliable and cost-effective laboratory consumables**. With a commitment to excellence and a passion for advancement, Microlit proudly introduces **Plasticus** - an extensive range of laboratory consumables, **engineered with accuracy**, designed to elevate scientific experimentation and discovery to new heights.



ISO 9001 Certificate



ISO 13485 Certificate



CE Certificate Micropipette & Bottle Top Dispensers



ISO 17025 (NABL) Certificate



CE Certificate Easyfill - Pipette Filling Device



CE Certificate E-Burette

## Company View



# TABLE OF CONTENTS

▶ <b>Cell Culture and Tissue Culture</b> .....	01
▶ Cell Culture Plate .....	03
▶ Cell Culture Flask .....	05
▶ Cell Culture Petri Dish .....	06
Petri Dish .....	06
▶ <b>Liquid Handling</b> .....	07
▶ Pipette Tips .....	09
Pipette Tips with Filter .....	11
Pipette Tips without Filter .....	12
▶ Low Retention Pipette Tips .....	13
Low Retention Pipette Tips with Filter .....	14
Low Retention Pipette Tips without Filter .....	14
▶ Serological Pipette .....	15
▶ Centrifuge Tube .....	17
Micro Centrifuge Tube .....	18
Centrifuge Tube - Foam Base .....	18
Centrifuge Tube Rack .....	19
▶ Screw Cap Tube .....	20
▶ <b>Molecular Biology</b> .....	21
▶ PCR Series .....	23
PCR Plate, 96-Well .....	24
PCR 8-Strip Tube .....	24
PCR Tube .....	24
▶ PCR Instrument Compatibility Chart .....	25
▶ Deep Well Plate and Magnetic Tip Comb .....	27
96-Well Deep Well Plate .....	27
96-Well Magnetic Tip Comb .....	27
▶ <b>Storage</b> .....	29
▶ Cryogenic Box .....	31
▶ Cryogenic Vial .....	32
▶ <b>Biochemistry</b> .....	33
▶ ELISA Plate .....	35

# CELL CULTURE AND TISSUE CULTURE

---

Cell Culture Plate

Cell Culture Flask

Cell Culture Petri Dish

Petri Dish



# Cell Culture Plate



Our Cell Culture Plates are manufactured using a highly transparent polystyrene material with 90% light transmission rate. The flat and uniform bottom design of the plates ensures that observation images are clear and free from distortion. Additionally, the plate cover is equipped with a cohesive ring that effectively prevents contamination or evaporation of the culture fluid, reducing the risk of edge effects. Each plate is packed in durable plastic packaging that minimizes the chances of breakage and maintains sterility. Moreover, all the plates undergo strict TC treatment, which is suitable for the culture of attached cells and semi-attached cells.

## Product Features

- ▶ **Material:** Polystyrene (PS)
- ▶ **Bottom:** Flat
- ▶ **Aseptic Processing:** Irradiation
- ▶ **Surface Treatment:** TC Treatment
- ▶ **Available Spec.:** 6-Well, 12-Well, 24-Well, 48-Well, 96-Well
- ▶ **Packaging:** Hard Plastic, Individually Wrapped
- ▶ **Certifications:** CE, FDA

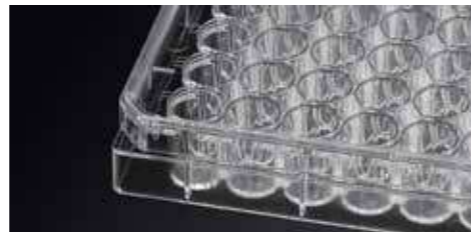

## Cell Culture Plate (Individually Wrapped)

Cat. No.	Surface Type	Specification (Well)	Pore Diameter (mm)	Packaging	
				Pcs/Box	Boxes/Carton
CPT-6W	TC-Treated	6	33.6	1	50
CPT-12W		12	26	1	50
CPT-24W		24	19.3	1	50
CPT-48W		48	13.1	1	50
CPT-96W		96	6.45	1	100

Note: TC-Treated means Tissue Culture Treated.  
\*Add suffix B after the Cat. No. for ordering the Bulk Pack.

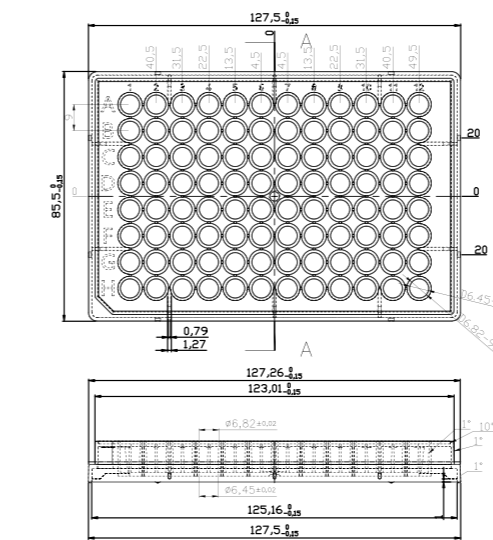
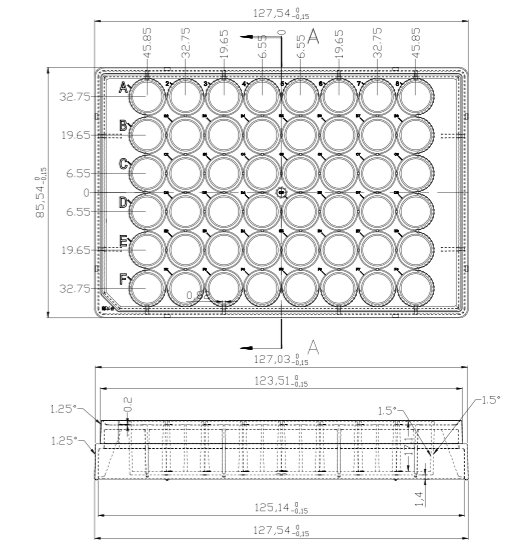
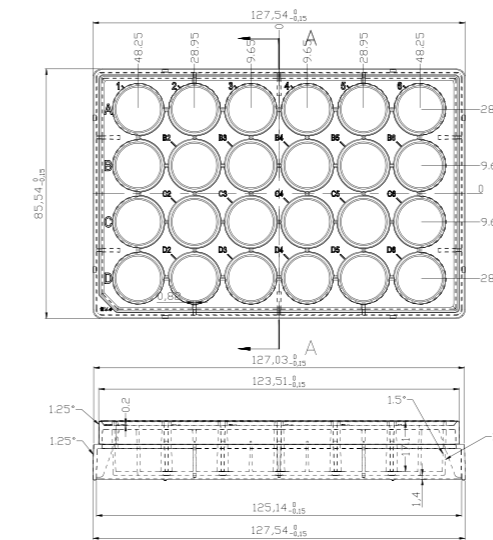
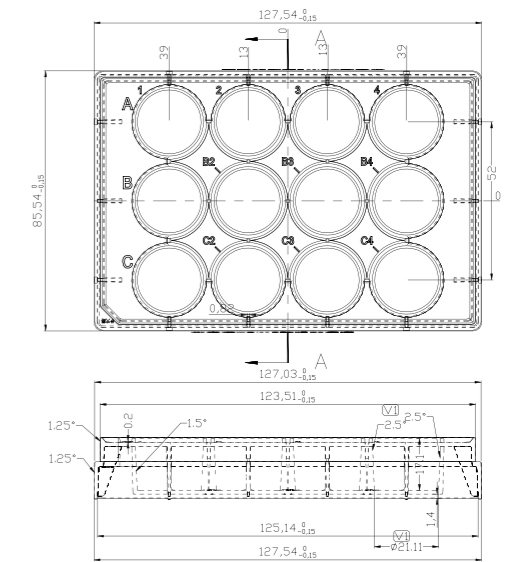
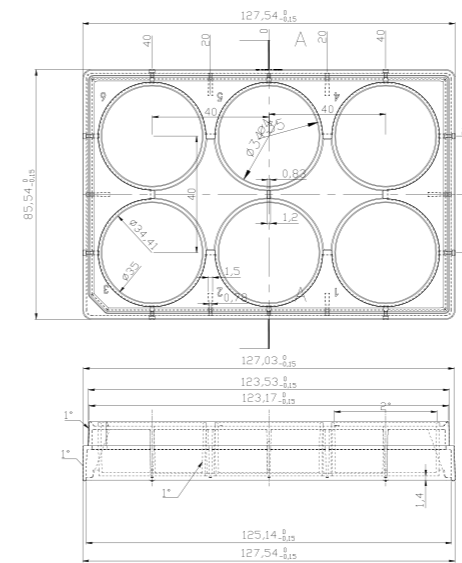

# Cell Culture Flask

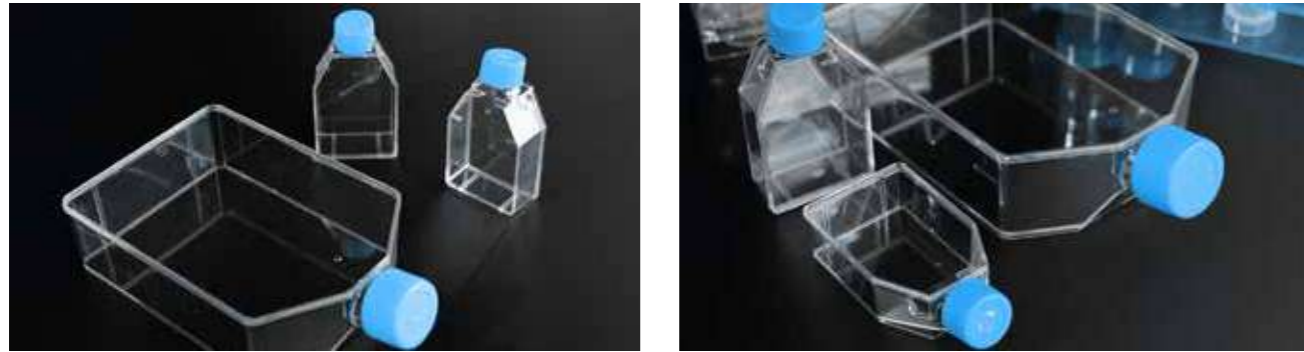

Our Cell Culture Flasks are designed for cultivating medium-sized cells in a lab setting. The top half of the flask has a special tilted design, along with the bottle mouth, which makes it convenient to use tools like serological pipettes and cell scrapers. The flasks come with sealed or vented bottle caps. They are made with precise irradiation sterilization and TC treatment, and the vacuum-sealed packaging guarantees that the product remains sterile and maintains its properties.

## Product Features

- ▶ **Material:** Polystyrene (PS)
- ▶ **Cap Types:** Sealed, Vented
- ▶ **Aseptic Processing:** Electron Beam
- ▶ **Surface Treatment:** TC Treatment
- ▶ **Available Spec:** 25 cm<sup>2</sup>, 75 cm<sup>2</sup>, 175 cm<sup>2</sup>
- ▶ **Packaging:** Vacuum plastic packing

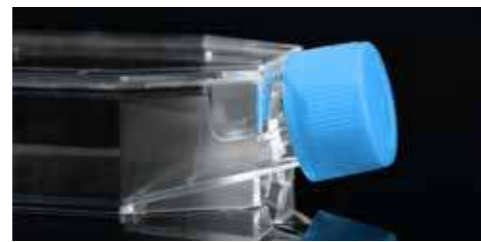

Beveled Bottle Neck

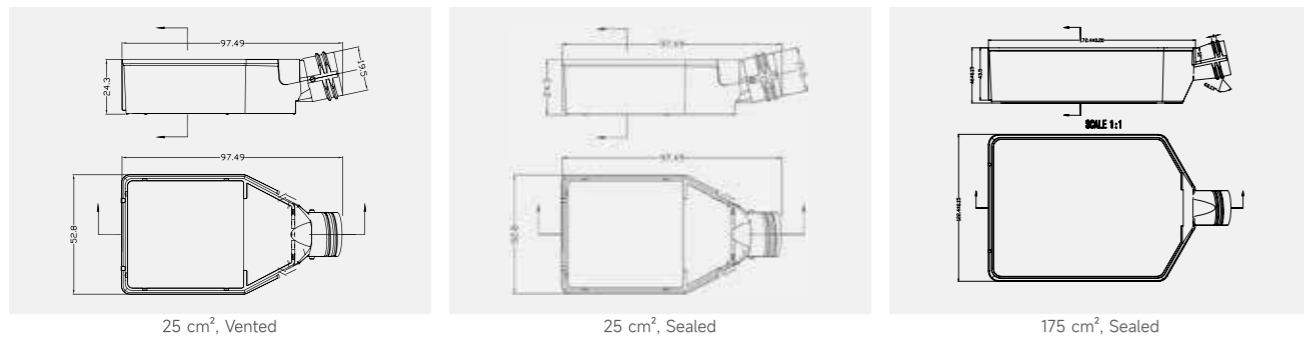

## Cell Culture Flask

Cat. No.	Surface Type	Cap Type	Height (mm)	Packaging	
				Pcs/Sleeve	Sleeves/Carton
CFTS-25	TC-Treated	Sealed	25	10	20
CFTS-75			75	5	20
CFTS-175			175	5	6
CFTV-25	TC-Treated	Vented	25	10	20
CFTV-75			75	5	20
CFTV-175			175	5	6

Note: TC-Treated means Tissue Culture Treated.  
\*Add suffix B after the Cat. No. for ordering the Bulk Pack.

# Cell Culture Petri Dish

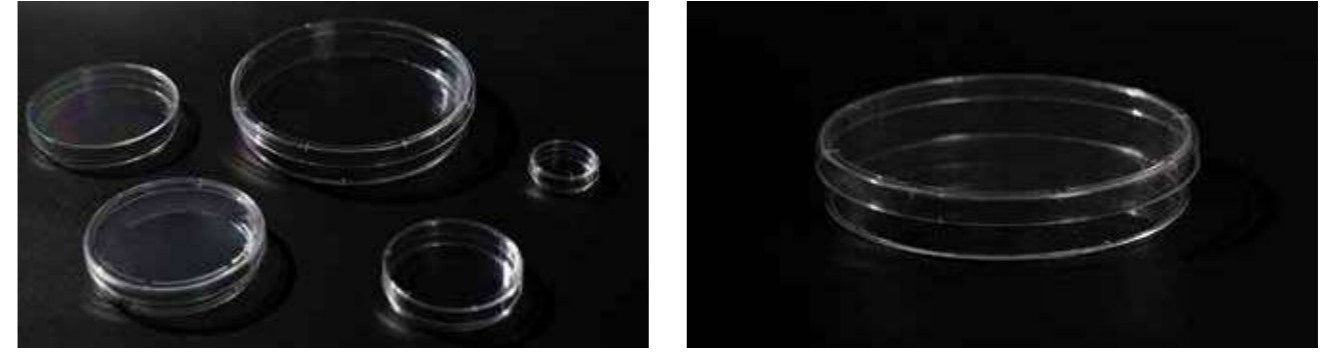

Our Cell Culture Dishes are suitable containers for cultivating cells, particularly for medium and small input volumes. These dishes can be used for various applications such as sample separation, pretreatment and storage. They are designed with precise sterilization techniques and are treated to maintain their tissue culture properties.

## Product Features

- ▶ **Material:** Polystyrene (PS)
- ▶ **Bottom:** Flat Bottom
- ▶ **Aseptic Processing:** Electron Beam
- ▶ **Surface Treatment:** TC Treatment/Non-TC Treatment
- ▶ **Cell Culture Petri Dish Spec.:** 35 mm, 60 mm, 100 mm, 150 mm
- ▶ **Petri Dish Spec.:** 60 mm, 90 mm
- ▶ **Certifications:** CE, FDA

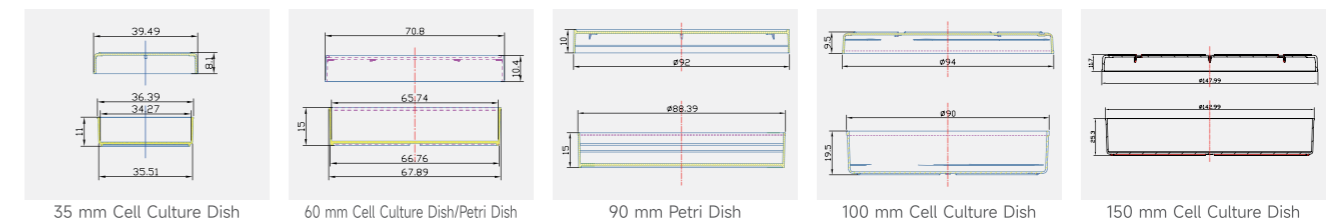

## Cell Culture Petri Dish

Cat. No.	Surface Type	Diameter (mm)	Height (mm)	Packaging	
				Pcs/Sleeve	Sleeves/Carton
PDT-35	TC-Treated	35	11	20	50
PDT-60		60	15	20	50
PDT-100		100	19.5	20	50
PDT-150		150	25.3	5	12

Note: TC-Treated means Tissue Culture Treated.

## Petri Dish

Cat. No.	Surface Type	Diameter (mm)	Height (mm)	Packaging	
				Pcs/Sleeve	Sleeves/Carton
PD-60	Non TC-Treated	60	11	20	25
PD-90		90	17	20	50

\*Add suffix B after the Cat. No. for ordering the Bulk Pack.

# LIQUID HANDLING

---

Pipette Tips with Filter

Pipette Tips

Low Retention Pipette Tips with Filter

Low Retention Pipette Tips

Serological Pipette

Centrifuge Tube

Micro Centrifuge Tube

Centrifuge Tube - Foam Base

Centrifuge Tube Rack

Screw Cap Tube



# Pipette Tips

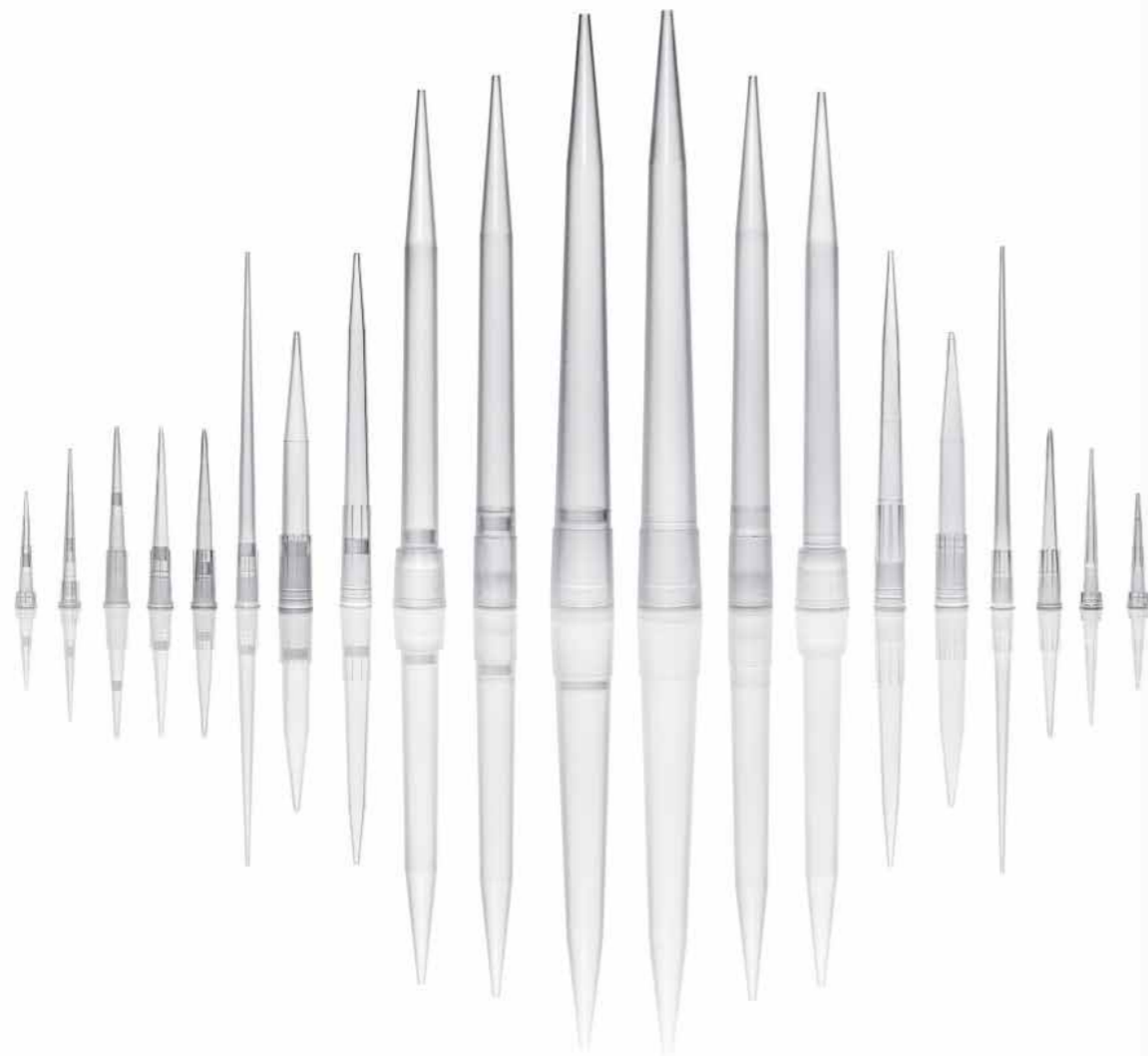

Our Pipette Tips are constructed from high-quality PP material sourced from abroad. These tips are expertly manufactured to prevent bending and feature a smooth inner wall due to a particular treatment. The inclusion of filters creates a protective barrier between the pipette and the sample, preventing contamination. This design ensures the safety of the sample and reduces the possibility of gas residue remaining in the pipette tip, safeguarding the operator during the pipetting procedure.

## Product Features

- ▶ **Tips Material:** Polypropylene (PP)
- ▶ **Filter Material:** Polyethylene (PE)
- ▶ **Color:** Natural
- ▶ **Specification:** 10 µL, 20 µL, 100 µL, 200 µL, 1000 µL, 5 mL, 10 mL
- ▶ **Aseptic Processing: Irradiation**  
Adapted Brands: Eppendorf, Thermo, Brand, Gilson, Rainin etc.
- ▶ **Certification:** CE, FDA, UKCA
- ▶ **Others:** Sterile, DNase & RNase Free, Pyrogen-free

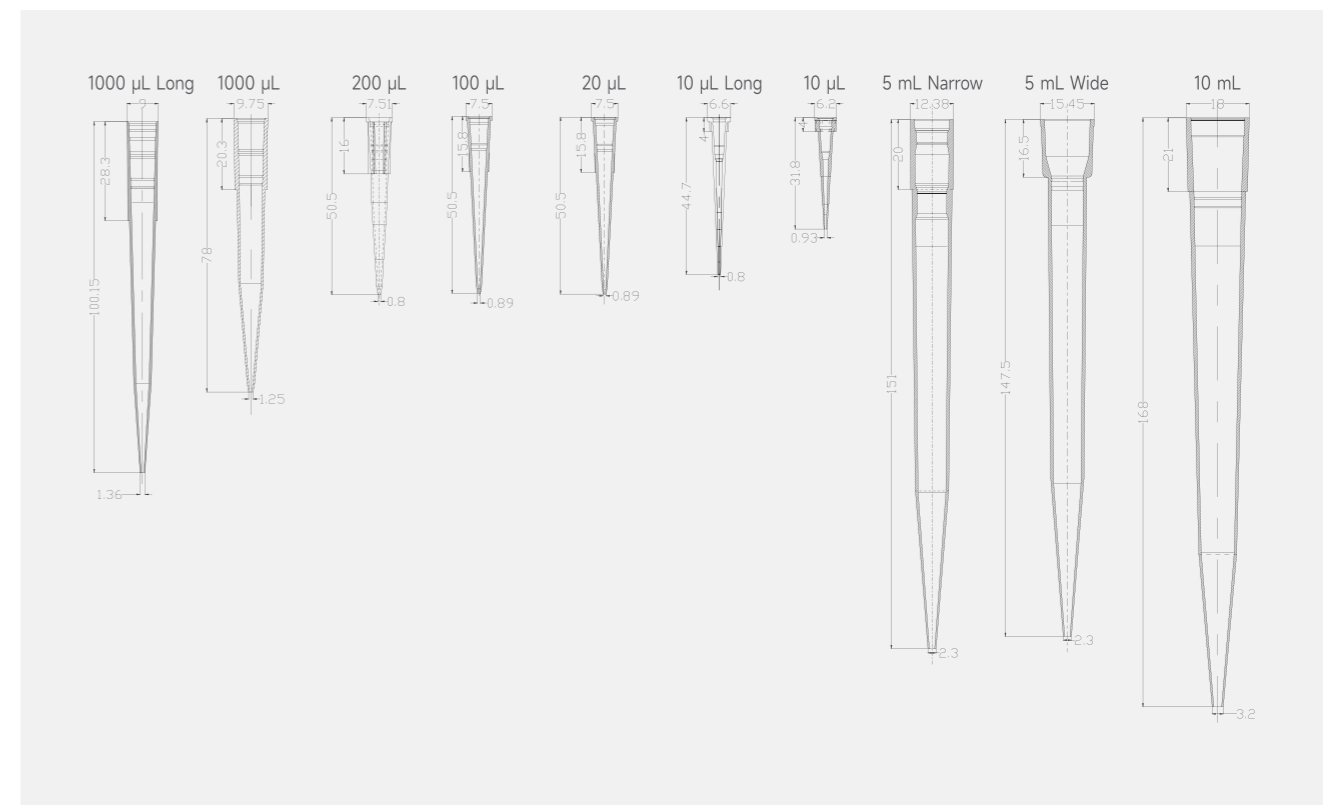



### Filter Tips

- 01) 10 µL
- 02) 10 µL Long
- 03) 20 µL
- 04) 100 µL
- 05) 200 µL
- 06) 200 µL Long
- 07) 1000 µL Short
- 08) 1000 µL Long
- 09) 5 mL Wide
- 10) 5 mL
- 11) 10 mL

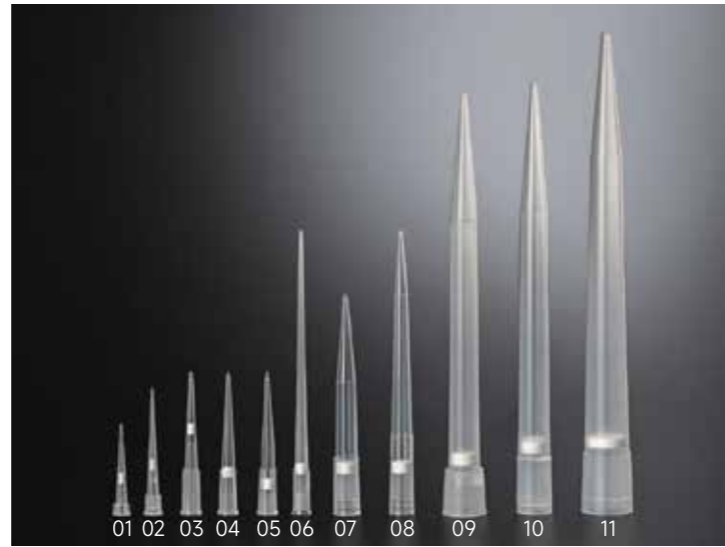

### Non Filter Tips

- 01) 10 µL
- 02) 10 µL Long
- 03) 200 µL
- 04) 200 µL Long
- 05) 1000 µL Short
- 06) 1000 µL Long
- 07) 5 mL Wide
- 08) 5 mL
- 09) 10 mL

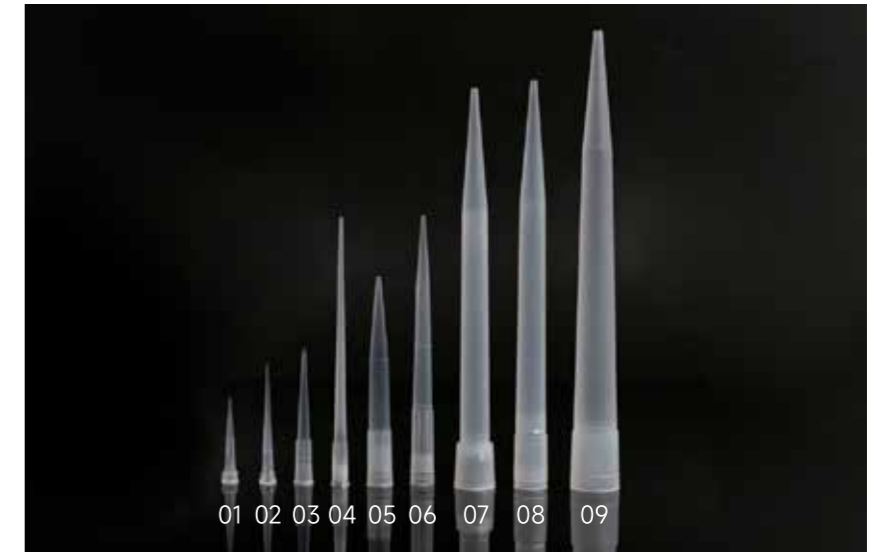

### Pipette Tips With Filter (Bag Packing)

Cat. No.	Capacity	Filter	Packaging Form	Packaging	
				Pcs/Bag	Bags/Carton
FTP-BG-10	10 µL	Y	Bagged	1000	10
FTP-BG-10L	10 µL Long	Y		1000	10
FTP-BG-20	20 µL	Y		1000	10
FTP-BG-100	100 µL	Y		1000	10
FTP-BG-200	200 µL	Y		1000	20
FTP-BG-1000	1000 µL	Y		500	10
FTP-BG-1000L	1000 µL Long	Y		500	10
FTP-BG-5000W	5 mL Wide	Y		100	20
FTP-BG-5000	5 mL	Y		100	20
FTP-BG-10000	10 mL	Y		100	10

### Pipette Tips (Bag Packing)

Cat. No.	Capacity	Filter	Packaging Form	Packaging	
				Pcs/Bag	Bags/Carton
TP-BG-10	10 µL	N	Bagged	1000	10
TP-BG-10S	10 µL	N		100	100
TP-BG-10L	10 µL Long	N		1000	10
TP-BG-200	200 µL	N		1000	20
TP-BG-200GL	200 µL Gel Loading	N		1000	15
TP-BG-300	300 µL	N		1000	20
TP-BG-1000	1000 µL	N		1000	5
TP-BG-1250	1250 µL	N		500	10
TP-BG-5000W	5 mL Wide	N		100	20
TP-BG-5000	5 mL	N		100	20
TP-BG-10000	10 mL	N		100	10
TP-BG-5000-EP	5 mL	N		100	20
TP-BG-10000-EP	10 mL	N		100	10

### Pipette Tips With Filter (Rack Packing)

Cat. No.	Capacity	Filter	Packaging Form	Packaging	
				Pcs/Rack	Racks/Carton
FTP-RK-10	10 µL	Y	Racked	96	100
FTP-RK-10L	10 µL Long	Y		96	100
FTP-RK-20	20 µL	Y		96	100
FTP-RK-100	100 µL	Y		96	100
FTP-RK-200	200 µL	Y		96	100
FTP-RK-200L	200 µL Long	Y		96	50
FTP-RK-1000	1000 µL	Y		96	50
FTP-RK-1000L	1000 µL Long	Y		96	50
FTP-RK-5000W	5 mL Wide	Y		28	50
FTP-RK-5000	5 mL	Y		28	50
FTP-RK-10000	10 mL	Y		24	50

### Pipette Tips (Rack Packing)

Cat. No.	Capacity	Filter	Packaging Form	Packaging	
				Pcs/Rack	Racks/Carton
TP-RK-10	10 µL	N	Racked	96	100
TP-RK-10L	10 µL Long	N		96	100
TP-RK-200	200 µL	N		96	100
TP-RK-200L	200 µL Long	N		96	50
TP-RK-200GL	200 µL Gel Loading	N		96	50
TP-RK-300	300 µL	N		96	100
TP-RK-1000	1000 µL	N		96	50
TP-RK-1000L	1000 µL Long	N		96	50
TP-RK-5000W	5 mL Wide	N		28	50
TP-RK-5000	5 mL	N		28	50
TP-RK-10000	10 mL	N		24	50
TP-RK-5000-EP	5 mL	N		28	50
TP-RK-10000-EP	10 mL	N		24	50

\*Add suffix B after the Cat. No. for ordering the Bulk Pack.

\*Add suffix B after the Cat. No. for ordering the Bulk Pack.

# Low Retention Pipette Tips



Our low retention pipette tips are made from imported PP material to ensure they have high quality and do not bend. The inner wall has been treated to be made smooth, preventing liquids from hanging on the wall and reducing the loss of samples or saving reagents. This treatment also effectively prevents poor linearity, low response, or concentration changes that can be caused by adsorption and other factors. Plasticus low retention pipette tips have the following benefits during experiments: they reduce sample residue, leading to improved accuracy and precision, ultimately enhancing sample recovery. It is worth noting that low-retention pipette tips are especially crucial in protein and nucleic acid research.

## Product Features

- ▶ **Material:** Polypropylene (PP)
- ▶ **Filter Material:** Polyethylene (PE)
- ▶ **Color:** Natural
- ▶ **Absorption treatment:** Low Retention Treatment
- ▶ **Specification:** 10 µL, 20 µL, 100 µL, 200 µL, 1000 µL
- ▶ **Aseptic Processing:** Irradiation
- ▶ **Adapted Brands:** Eppendorf, Thermo, Brand, Gilson, Rainin etc.
- ▶ **Certification:** CE, FDA, UKCA
- ▶ **Others:** Sterile, DNase & RNase Free, Pyrogen-free



## Low Retention Pipette Tips With Filter (Bag Packing)

Cat. No.	Capacity	Filter	Packaging Form	Packaging	
				Pcs/Bag	Bags/Carton
LRFTP-BG-10	10 µL	Y	Bagged	1000	10
LRFTP-BG-10L	10 µL Long	Y		1000	10
LRFTP-BG-20	20 µL	Y		1000	20
LRFTP-BG-100	100 µL	Y		1000	20
LRFTP-BG-200	200 µL	Y		1000	20
LRFTP-BG-1000L	1000 µL Long	Y		500	10
LRFTP-BG-1000	1000 µL	Y		500	10

## Low Retention Pipette Tips With Filter (Rack Packing)

Cat. No.	Capacity	Filter	Packaging Form	Packaging	
				Pcs/Rack	Racks/Carton
LRFTP-RK-10	10 µL	Y	Racked	96	100
LRFTP-RK-10L	10 µL Long	Y		96	100
LRFTP-RK-20	20 µL	Y		96	100
LRFTP-RK-100	100 µL	Y		96	100
LRFTP-RK-200	200 µL	Y		96	100
LRFTP-RK-1000	1000 µL	Y		96	50
LRFTP-RK-1000L	1000 µL Long	Y		96	50

## Low Retention Pipette Tips (Bag Packing)

Cat. No.	Capacity	Filter	Packaging Form	Packaging	
				Pcs/Bag	Bags/Carton
LRTP-BG-10	10 µL	N	Bagged	1000	10
LRTP-BG-10L	10 µL Long	N		1000	10
LRTP-BG-200	200 µL	N		1000	20
LRTP-BG-1000	1000 µL	N		500	10
LRTP-BG-1250	1250 µL	N		500	10

## Low Retention Pipette Tips (Rack Packing)

Cat. No.	Capacity	Filter	Packaging Form	Packaging	
				Pcs/Rack	Racks/Carton
LRTP-RK-10	10 µL	N	Racked	96	100
LRTP-RK-10L	10 µL Long	N		96	100
LRTP-RK-200	200 µL	N		96	100
LRTP-RK-1000	1000 µL	N		96	50
LRTP-RK-1250	1250 µL	N		96	50

\*Add suffix B after the Cat. No. for ordering the Bulk Pack.

# Serological Pipette



Our serological pipettes are predominantly utilized for precise measurement or transfer of specific liquid volumes, finding extensive application in cell culture, bacteriology, clinical practices, scientific research and various other domains.

## Product Features

- ▶ **Pipette Material:** Polystyrene (PS)
- ▶ **Filter Material:** Polyethylene (PE)
- ▶ **Available Volumes:** 1 mL, 2 mL, 5 mL, 10 mL, 25 mL, 50 mL
- ▶ **Capacity deviation rate:** <3%
- ▶ **Packing Form:** Individually Wrapped

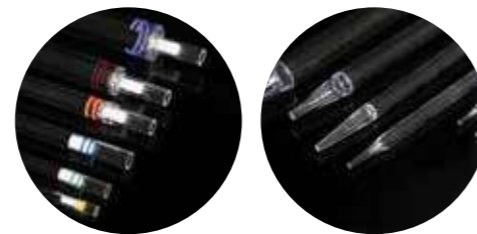

## Serological Pipette (Individually Wrapped)

Cat. No.	Capacity (mL)	Filter Color	Sterile	Packaging	
				Pcs/Bag	Bags/Carton
SP-1	1	Yellow	Y	50	20
SP-2	2	Green	Y	50	10
SP-5	5	Blue	Y	50	4
SP-10	10	Orange	Y	50	4
SP-25	25	Pink	Y	50	4
SP-50	50	Purple	Y	25	4

Note: One piece is packed in one sleeve.

\*Add suffix B after the Cat. No. for ordering the Bulk Pack.

## Applications in Biological and Chemical Laboratories

**Cell Culture:** In cell culture work, serological pipettes are used for transferring cell suspensions, media and reagents with precision and accuracy. They facilitate the seeding of cells into culture dishes, the addition of growth media and the removal of spent media during cell passaging.

**Sample Preparation:** Serological pipettes are essential for preparing samples in molecular biology applications such as DNA extraction, PCR and gel electrophoresis. They enable precise measurement and transfer of buffers, enzymes, and nucleic acid samples, ensuring reproducible results.

**Biomedical Research:** In biomedical research, serological pipettes are utilized for various tasks, including protein purification, enzyme assays, and cell-based assays. They enable researchers to accurately dispense reagents, perform dilutions and carry out biochemical reactions with precision.

**Diagnostic Testing:** Serological pipettes are commonly used in clinical and diagnostic laboratories for performing tests such as ELISA, immunoassays and blood typing. They facilitate the accurate dispensing of samples, antibodies and other reagents, ensuring reliable test results.

**Drug Discovery:** In pharmaceutical research and drug discovery, serological pipettes are employed for screening compounds, conducting assays, and preparing solutions for high-throughput screening. They play a vital role in the precise measurement and transfer of drug candidates and assay components.

## Applications in Food and Beverage Industry

**Quality Control:** In food production facilities, serological pipettes are used for quality control purposes, including testing raw materials, monitoring production processes and ensuring product consistency. They enable precise measurement and dispensing of ingredients, additives and solutions.

**Beverage Analysis:** In beverage manufacturing, serological pipettes are employed for analyzing samples for parameters such as acidity, sugar content and alcohol concentration. They facilitate accurate measurement and transfer of liquid samples, ensuring compliance with regulatory standards and product specifications.

**Research and Development:** Serological pipettes are used in R&D laboratories of food and beverage companies for product development, formulation studies, and process optimization.



## Applications in Environmental Testing

**Water Quality Analysis:** In environmental laboratories, serological pipettes are used for testing water quality parameters such as pH, dissolved oxygen, and nutrient levels. They facilitate the accurate measurement and dispensing of reagents and samples, ensuring reliable analytical results.

**Soil and Sediment Analysis:** Serological pipettes are employed for preparing soil and sediment samples for analysis, including extraction, digestion, and filtration procedures. They enable researchers to handle samples with precision and consistency, contributing to accurate analytical results.

**Air Quality Monitoring:** In air quality monitoring studies, serological pipettes are utilized for collecting air samples and preparing them for analysis. They enable researchers to measure pollutant concentrations, particulate matter levels and microbial content with accuracy and reliability.

# Centrifuge Tube



Our Centrifuge Tube is composed of a transparent polymer material called polypropylene PP. It serves the primary purpose of storing, transporting, and subjecting samples to centrifugation.

## Product Features

- ▶ Material: Polypropylene (PP)
- ▶ Temperature Tolerances: -80°C to 121°C
- ▶ Specification: 1.5 mL, 2 mL, 15 mL, 50 mL
- ▶ Aseptic Processing: Irradiation
- ▶ Certification: CE, FDA, UKCA
- ▶ Others: Sterile, DNase & RNase Free, Pyrogen-Free

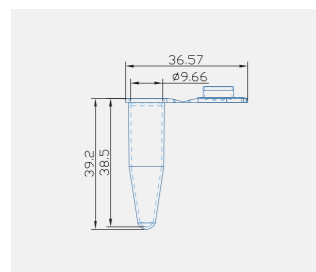
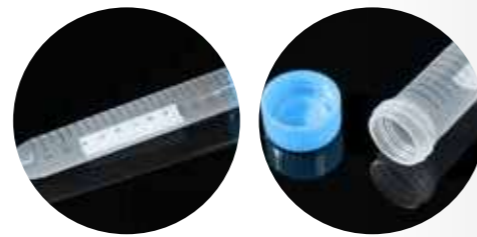

1.5 mL Centrifuge Tube

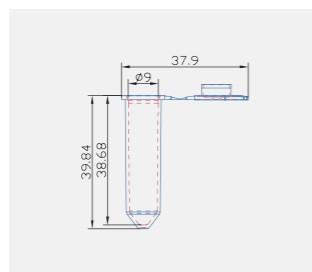

2 mL Centrifuge Tube

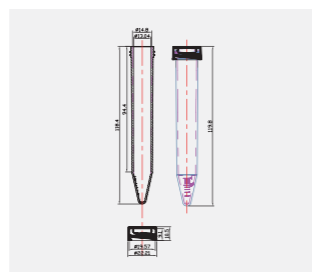

15 mL Centrifuge Tube

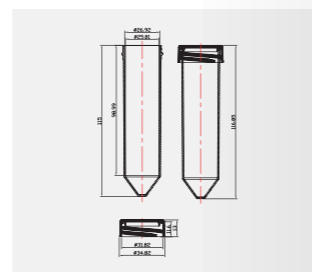

50 mL Centrifuge Tube

## Centrifuge Tube (Bag Packing)

Cat. No.	Volume (mL)	Bottom Type	Max Rotate Speed (g)	Packaging Form	Packaging	
					Pcs/Bag	Bags/Carton
CT-1500	15	Conical	17500	Bagged	50	10
CT-5000	50	Conical	17500		25	20
CT-5010	50	Round	17500		25	20
CT-5020-S	50	Conical, Self-standing	17500		25	20
CT-5030-S	50	Round, Self-standing	17500		25	20

## Centrifuge Tube (Individually Wrapped)

Cat. No.	Volume (mL)	Bottom Type	Max Rotate Speed (g)	Packaging Form	Packaging	
					Pcs/Bag	Bags/Carton
CT-1501	15	Conical	17500	Individually Wrapped	50	10
CT-5001	50	Conical	17500		25	20

## Micro Centrifuge Tube (Bag Packing)

Cat. No.	Volume (mL)	Bottom Type	Max Rotate Speed (g)	Packaging Form	Packaging	
					Pcs/Bag	Bags/Carton
MCT-150	1.5	Conical	18000	Bagged	500	10
MCT-200	2	Conical	18000		500	10

## Centrifuge Tube - Foam Base (Bag Packing)

Cat. No.	Volume (mL)	Bottom Type	Max Rotate Speed (g)	Packaging Form	Packaging	
					Pcs/Bag	Bags/Carton
CT-1500-F	15	Conical	17500	Foam Base	50	10
CT-5000-F	50	Conical	17500		25	20

\*Add suffix B after the Cat. No. for ordering the Bulk Pack.



# Centrifuge Tube Rack

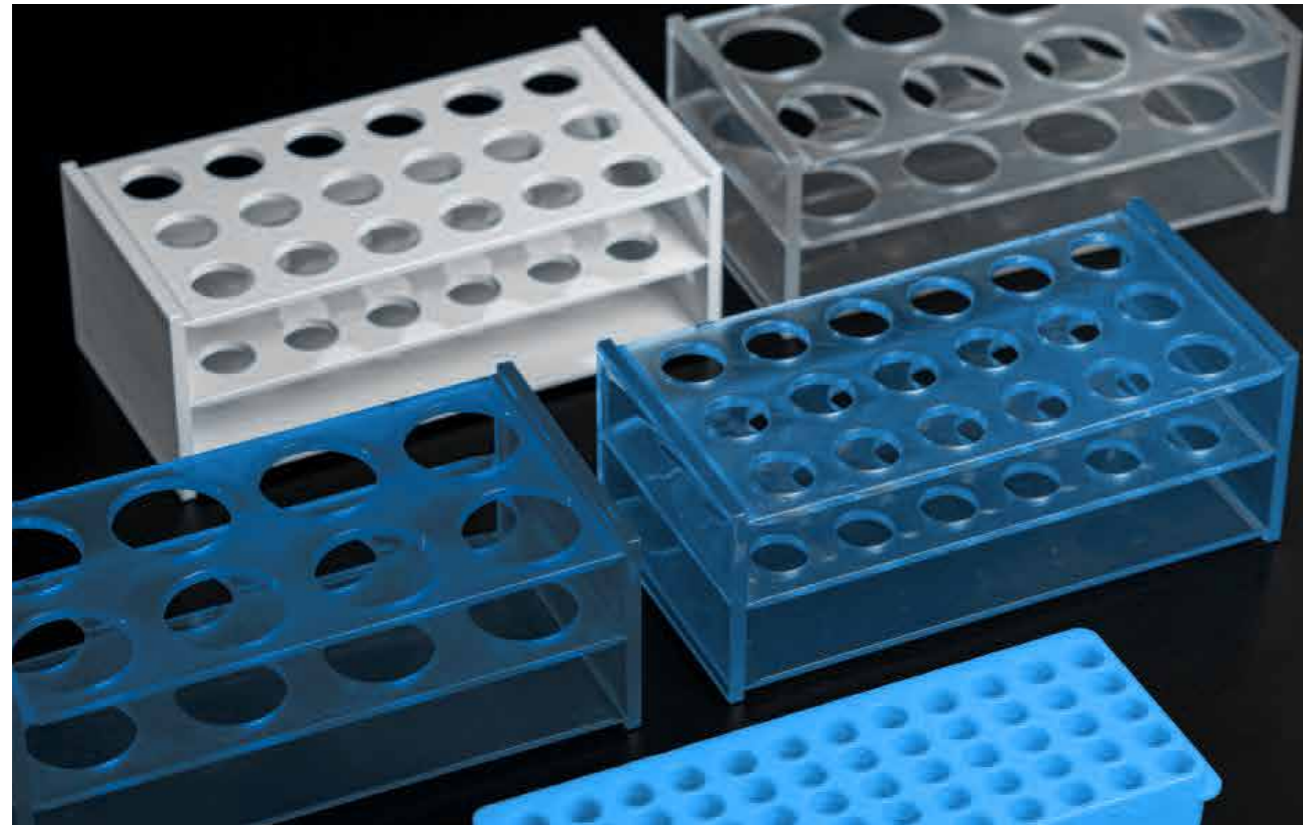

Our Centrifuge Tube Racks are vital laboratory accessories designed to securely hold and organize centrifuge tubes during high-speed centrifugation processes. Constructed from durable materials, these racks accommodate various tube sizes, providing a stable platform to prevent spillage or breakage during rotation. They contribute to streamlined laboratory workflows. Centrifuge tube racks ensure the safety of samples, maintain tube integrity and enhance the overall efficiency of centrifugation procedures in diverse scientific applications, including molecular biology, biochemistry and clinical research.

## Centrifuge Tube Rack

Cat. No.	Specification	Color	Packaging	
			Pcs/Rack	Racks/Carton
CTR-200	60-Well	White / Blue	1	120
CTR-1500	18-Well	White / Blue	1	50
CTR-5000	8-Well	White / Blue	1	50

\*Add suffix B after the Cat. No. for ordering the Bulk Pack.

# Screw Cap Tube



Our Screw Cap Tube, which come with lids but no rubber rings, have multiple applications such as storing biochemical reagents or samples at low temperatures. The standing round bottom design of these tubes makes it easier to concentrate, recover and position samples.

## Product Features

- ▶ **Material:** Polypropylene (PP)
- ▶ **Available Volumes:** 0.5 mL, 1.5 mL, 2 mL
- ▶ **Temperature Tolerances:** -80 °C to 121 °C
- ▶ **Others:** DNase & RNase Free, Standing, Straight Knurl



## Screw Cap Tube

Cat. No.	Capacity (mL)	Cap Color	Packaging	
			Pcs/Bag	Bags/Carton
SCT-50-S	0.5	Grey	500	10
SCT-150-S	1.5	Grey	500	10
SCT-200-S	2	Grey	500	10

\*Add suffix B after the Cat. No. for ordering the Bulk Pack.

# MOLECULAR BIOLOGY

---

PCR Plate, 96-Well

PCR 8-Strip Tube

PCR Tube

96-Well Deep Well Plate

96-Well Magnetic Tip Comb

# PCR Series

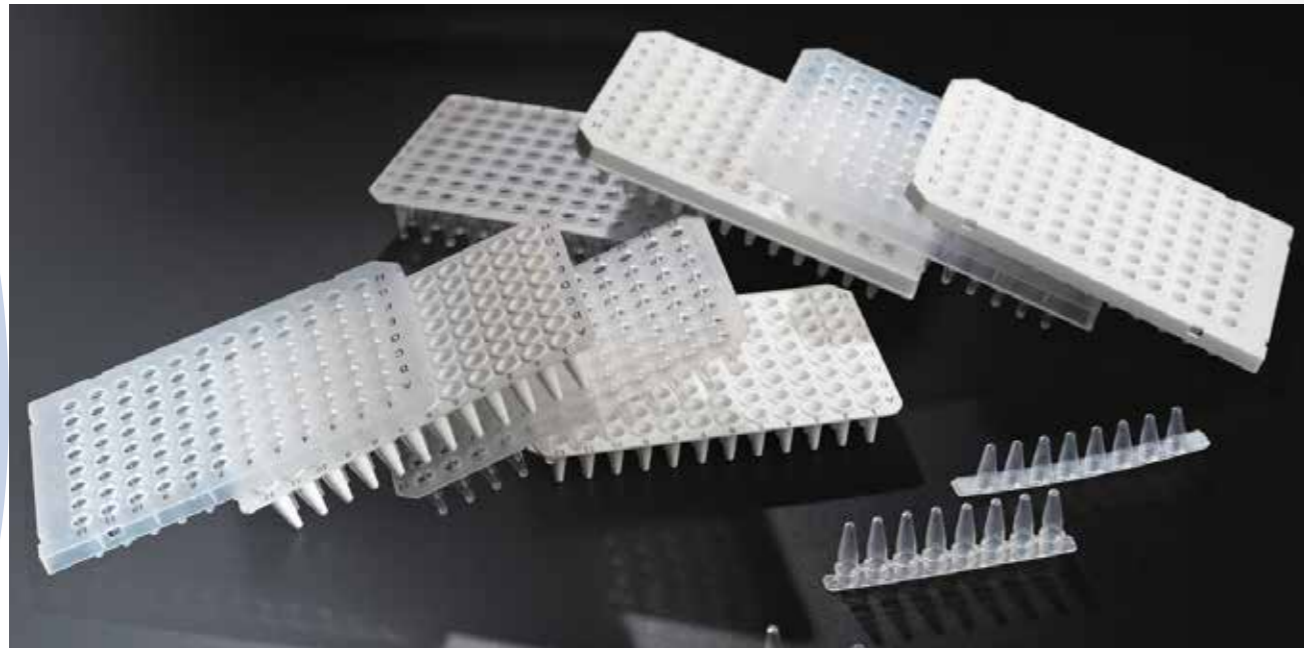

Our PCR plate series is comprised of high-quality PP material and is meticulously designed to possess excellent concentricity and tube mouth flatness. This ensures that there is no leakage when sealed. The thin tube wall and consistent thickness of the tube body guarantee uniform product heating. These PCR plates find extensive application in various fields such as genetics, biochemistry, immunity and medicine. They are used not only in fundamental research involving gene isolation, cloning, and nucleic acid sequence analysis, but also in disease diagnosis or involving DNA or RNA. In addition, white PCR plates and 8-tube variants are also available. The use of opaque white reaction plates helps enhance the sensitivity and consistency of qPCR data by preventing fluorescence refraction, thus enabling better cooperation with qPCR experiments.

## Product Features

- ▶ Pipette Material: Polypropylene (PP)
- ▶ Available Specs: 96-Well, 8-strip tube, Single tube
- ▶ Aseptic Processing: Irradiation
- ▶ Compatible Brands: Various brands of PCR instruments
- ▶ Certifications: CE, FDA, UKCA

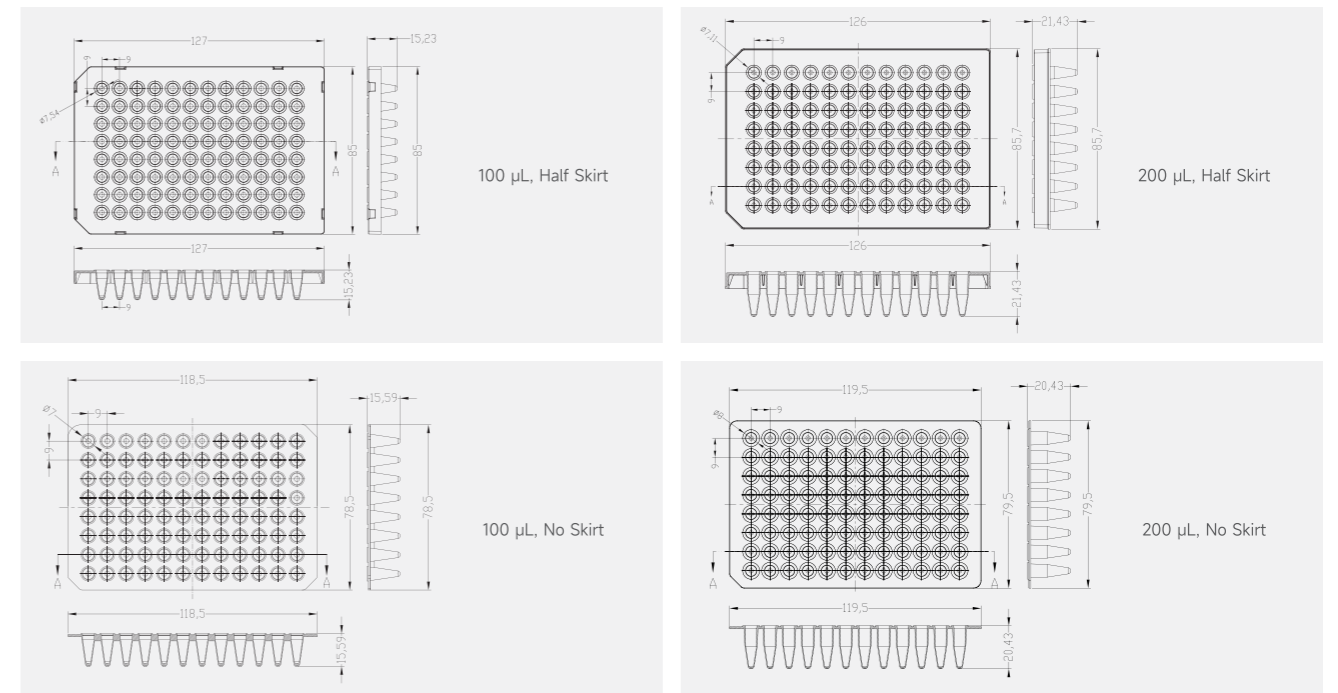
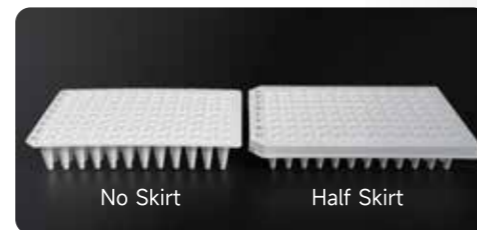

## PCR Plate, 96-Well

Cat. No.	Specification (mL)	Color	Pore Diameter (mm)	Dimension (mm)	Packaging	
					Pcs/Box	Boxes/Carton
PCR-96-1-NS	0.1	Transparent	5.83	118.5*78.5*15.59	10	10
PCR-96-1-HS	0.1		5.35	127*85*15.43	10	10
PCR-96-2-NS	0.2		5.3	119.5*79.5*20.43	10	10
PCR-96-2-HS	0.2		5.31	126*85.7*21.43	10	10
PCR-96-1W-NS	0.1	White	5.83	118.5*78.5*15.59	10	10
PCR-96-1W-HS	0.1		5.35	127*85*15.43	10	10
PCR-96-2W-NS	0.2		5.3	119.5*79.5*20.43	10	10
PCR-96-2W-HS	0.2		5.31	126*85.7*21.43	10	10

Note: NS means No Skirt and HS means Half Skirt.

## PCR 8-Strip Tube

Cat. No.	Specification (mL)	Color	Pore Diameter (mm)	Dimension (mm)	Packaging	
					Pcs/Box	Boxes/Carton
PCR-8-100-C	0.1	Transparent	5.2	81.3*15	125	10
PCR-8-200-C	0.2	Transparent	5.2	71.15*20.5	125	10
PCR-8-100W-C	0.1	White	5.2	81.3*15	125	10
PCR-8-200W-C	0.2	White	5.2	71.15*20.5	125	10

## PCR Tube

Cat. No.	Specification (mL)	Color	Pore Diameter (mm)	Dimension (mm)	Packaging	
					Pcs/Box	Boxes/Carton
PCR-2-C	0.2	Transparent	NA	NA	1000	10

\*Add suffix B after the Cat. No. for ordering the Bulk Pack.

PCR Instrument Compatibility Chart

Brands	Model No.	"PCR-96-1-NS PCR-96-1W-NS (PCR-96-1W-NS is white model, the compatibility is the same as the transparent model)"	"PCR-96-2-NS PCR-96-2W-NS (PCR-96-2W-NS is white model, the compatibility is the same as the transparent model)"	"PCR-96-1-HS PCR-96-1W-HS (PCR-96-1W-HS is white model, the compatibility is the same as the transparent model)"	"PCR-96-2-HS PCR-96-2W-HS (PCR-96-2W-HS is white model, the compatibility is the same as the transparent model)"	"PCR-8-100-C PCR-8-100W-C (PCR-8-100W-C is white model, the compatibility is the same as the transparent model)"	"PCR-8-200-C PCR-8-200W-C (PCR-8-200W-C is white model, the compatibility is the same as the transparent model)"	PCR-2-C
Applied Biosystems	2720		PCR-96-2-NS		PCR-96-2-HS		PCR-8-200-C	PCR-2-C
	9600		PCR-96-2-NS		PCR-96-2-HS		PCR-8-200-C	PCR-2-C
	9700		PCR-96-2-NS		PCR-96-2-HS		PCR-8-200-C	PCR-2-C
	9800Fast	PCR-96-1-NS		PCR-96-1-HS		PCR-8-100-C		
	Veriti/Fast	PCR-96-1-NS	PCR-96-2-NS	PCR-96-1-HS	PCR-96-2-HS	PCR-8-100-C	PCR-8-200-C	PCR-2-C
	7300		PCR-96-2-NS		PCR-96-2-HS		PCR-8-200-C	PCR-2-C
	7500/Fast		PCR-96-2-NS	PCR-96-1-HS			PCR-8-200-C	PCR-2-C
	7700		PCR-96-2-NS		PCR-96-2-HS		PCR-8-200-C	PCR-2-C
	7900HT/Fast	PCR-96-1-NS	PCR-96-2-NS	PCR-96-1-HS	PCR-96-2-HS	PCR-8-100-C	PCR-8-200-C	PCR-2-C
	StepOne	PCR-96-1-NS		PCR-96-1-HS		PCR-8-100-C	PCR-8-200-C	PCR-2-C
	SteOnePlus	PCR-96-1-NS		PCR-96-1-HS		PCR-8-100-C	PCR-8-200-C	PCR-2-C
	ProflexPCRSytem		PCR-96-2-NS		PCR-96-2-HS		PCR-8-200-C	PCR-2-C
	QuantStudio 12K		PCR-96-2-NS		PCR-96-2-HS		PCR-8-200-C	PCR-2-C
	ViiA7/Fast	PCR-96-1-NS	PCR-96-2-NS	PCR-96-1-HS	PCR-96-2-HS	PCR-8-100-C	PCR-8-200-C	PCR-2-C
	3100		PCR-96-2-NS		PCR-96-2-HS		PCR-8-200-C	PCR-2-C
	3130		PCR-96-2-NS		PCR-96-2-HS		PCR-8-200-C	PCR-2-C
	3700		PCR-96-2-NS		PCR-96-2-HS		PCR-8-200-C	PCR-2-C
3730/3730x		PCR-96-2-NS		PCR-96-2-HS		PCR-8-200-C	PCR-2-C	
C1000 Touch		PCR-96-2-NS		PCR-96-2-HS		PCR-8-200-C	PCR-2-C	
Bio-rad	DNA Engine Dyad /Dyad Disciple		PCR-96-2-NS		PCR-96-2-HS		PCR-8-200-C	PCR-2-C
	Engine Tetrad 2		PCR-96-2-NS		PCR-96-2-HS		PCR-8-200-C	PCR-2-C
	MyCycler		PCR-96-2-NS		PCR-96-2-HS		PCR-8-200-C	PCR-2-C
	PTC-100		PCR-96-2-NS		PCR-96-2-HS		PCR-8-200-C	PCR-2-C
	PTC-200		PCR-96-2-NS		PCR-96-2-HS		PCR-8-200-C	PCR-2-C
	PTC-225 Tetrad		PCR-96-2-NS		PCR-96-2-HS		PCR-8-200-C	PCR-2-C
	S1000		PCR-96-2-NS		PCR-96-2-HS		PCR-8-200-C	PCR-2-C
	T100		PCR-96-2-NS		PCR-96-2-HS		PCR-8-200-C	PCR-2-C
	CFX Connect		PCR-96-2-NS		PCR-96-2-HS		PCR-8-200-C	PCR-2-C
	CFX96 Touch/ CFX96	PCR-96-1-NS				PCR-8-100-C		
	Chromo4		PCR-96-2-NS		PCR-96-2-HS		PCR-8-200-C	PCR-2-C
	DNA Engine Opticon 2		PCR-96-2-NS		PCR-96-2-HS		PCR-8-200-C	PCR-2-C
	iCycler		PCR-96-2-NS		PCR-96-2-HS		PCR-8-200-C	PCR-2-C
	iQ 5		PCR-96-2-NS		PCR-96-2-HS		PCR-8-200-C	PCR-2-C
	MiniOpticon		PCR-96-2-NS		PCR-96-2-HS		PCR-8-200-C	PCR-2-C
	MyiQ		PCR-96-2-NS		PCR-96-2-HS		PCR-8-200-C	PCR-2-C
	Opticon	PCR-96-1-NS				PCR-8-100-C		
miniOpticon	PCR-96-1-NS				PCR-8-100-C			
Eppendorf	Mastercycler		PCR-96-2-NS		PCR-96-2-HS		PCR-8-200-C	PCR-2-C
	Mastercycler ep realplex		PCR-96-2-NS		PCR-96-2-HS		PCR-8-200-C	PCR-2-C
	Mastercycler ep		PCR-96-2-NS		PCR-96-2-HS		PCR-8-200-C	PCR-2-C
	Mastercycler nexus		PCR-96-2-NS		PCR-96-2-HS		PCR-8-200-C	PCR-2-C
	Mastercycler nexus eco		PCR-96-2-NS		PCR-96-2-HS		PCR-8-200-C	PCR-2-C
	Mastercycler nexus gradient		PCR-96-2-NS		PCR-96-2-HS		PCR-8-200-C	PCR-2-C
	Mastercycler nexus gradient eco		PCR-96-2-NS		PCR-96-2-HS		PCR-8-200-C	PCR-2-C

PCR Instrument Compatibility Chart

Brands	Model No.	"PCR-96-1-NS PCR-96-1W-NS (PCR-96-1W-NS is white model, the compatibility is the same as the transparent model)"	"PCR-96-2-NS PCR-96-2W-NS (PCR-96-2W-NS is white model, the compatibility is the same as the transparent model)"	"PCR-96-1-HS PCR-96-1W-HS (PCR-96-1W-HS is white model, the compatibility is the same as the transparent model)"	"PCR-96-2-HS PCR-96-2W-HS (PCR-96-2W-HS is white model, the compatibility is the same as the transparent model)"	"PCR-8-100-C PCR-8-100W-C (PCR-8-100W-C is white model, the compatibility is the same as the transparent model)"	"PCR-8-200-C PCR-8-200W-C (PCR-8-200W-C is white model, the compatibility is the same as the transparent model)"	PCR-2-C	
Eppendorf	Mastercycler nexus GSX1		PCR-96-2-NS		PCR-96-2-HS		PCR-8-200-C	PCR-2-C	
	Mastercycler nexus GSX1e		PCR-96-2-NS		PCR-96-2-HS		PCR-8-200-C	PCR-2-C	
	Mastercycler nexus SX1		PCR-96-2-NS		PCR-96-2-HS		PCR-8-200-C	PCR-2-C	
	Mastercycler nexus SX1e		PCR-96-2-NS		PCR-96-2-HS		PCR-8-200-C	PCR-2-C	
	Mastercycler pro/S		PCR-96-2-NS		PCR-96-2-HS		PCR-8-200-C	PCR-2-C	
Analytik Jena/Biometra	FlexCycler	PCR-96-1-NS	PCR-96-2-NS		PCR-96-2-HS	PCR-8-100-C	PCR-8-200-C	PCR-2-C	
	T1 Thermal Cycler	PCR-96-1-NS	PCR-96-2-NS		PCR-96-2-HS	PCR-8-100-C	PCR-8-200-C	PCR-2-C	
	TGradient	PCR-96-1-NS	PCR-96-2-NS		PCR-96-2-HS	PCR-8-100-C	PCR-8-200-C	PCR-2-C	
	Tpersonal	PCR-96-1-NS	PCR-96-2-NS		PCR-96-2-HS	PCR-8-100-C	PCR-8-200-C	PCR-2-C	
	TProfessional /Basic	PCR-96-1-NS	PCR-96-2-NS		PCR-96-2-HS	PCR-8-100-C	PCR-8-200-C	PCR-2-C	
	TProfessional /Standard	PCR-96-1-NS	PCR-96-2-NS		PCR-96-2-HS	PCR-8-100-C	PCR-8-200-C	PCR-2-C	
	TProfessional/TIRO	PCR-96-1-NS	PCR-96-2-NS		PCR-96-2-HS	PCR-8-100-C	PCR-8-200-C	PCR-2-C	
	TRobot	PCR-96-1-NS	PCR-96-2-NS		PCR-96-2-HS	PCR-8-100-C	PCR-8-200-C	PCR-2-C	
	Uno	PCR-96-1-NS	PCR-96-2-NS		PCR-96-2-HS	PCR-8-100-C	PCR-8-200-C	PCR-2-C	
	Uno II	PCR-96-1-NS	PCR-96-2-NS		PCR-96-2-HS	PCR-8-100-C	PCR-8-200-C	PCR-2-C	
	q TOWER		PCR-96-2-NS		PCR-96-2-HS		PCR-8-200-C	PCR-2-C	
	SpeedCycler		PCR-96-2-NS		PCR-96-2-HS		PCR-8-200-C	PCR-2-C	
	TOptical		PCR-96-2-NS		PCR-96-2-HS		PCR-8-200-C	PCR-2-C	
	Thermo	Multiblock System	PCR-96-1-NS	PCR-96-2-NS		PCR-96-2-HS	PCR-8-100-C	PCR-8-200-C	PCR-2-C
		T1 Thermal Cycler	PCR-96-1-NS	PCR-96-2-NS		PCR-96-2-HS	PCR-8-100-C	PCR-8-200-C	PCR-2-C
Omn-E		PCR-96-1-NS	PCR-96-2-NS		PCR-96-2-HS	PCR-8-100-C	PCR-8-200-C	PCR-2-C	
Omnigene		PCR-96-1-NS				PCR-8-100-C		PCR-2-C	
PCR Express		PCR-96-1-NS	PCR-96-2-NS		PCR-96-2-HS	PCR-8-100-C	PCR-8-200-C	PCR-2-C	
PCR Sprint			PCR-96-2-NS		PCR-96-2-HS		PCR-8-200-C	PCR-2-C	
Px2		PCR-96-1-NS	PCR-96-2-NS		PCR-96-2-HS	PCR-8-100-C	PCR-8-200-C	PCR-2-C	
PxE		PCR-96-1-NS	PCR-96-2-NS		PCR-96-2-HS	PCR-8-100-C	PCR-8-200-C	PCR-2-C	
Touchdown		PCR-96-1-NS	PCR-96-2-NS		PCR-96-2-HS	PCR-8-100-C	PCR-8-200-C	PCR-2-C	
Techne		Cyclogene		PCR-96-2-NS		PCR-96-2-HS		PCR-8-200-C	PCR-2-C
	Flexigene		PCR-96-2-NS		PCR-96-2-HS		PCR-8-200-C	PCR-2-C	
	Genius		PCR-96-2-NS		PCR-96-2-HS		PCR-8-200-C	PCR-2-C	
	Genius Quad		PCR-96-2-NS		PCR-96-2-HS		PCR-8-200-C	PCR-2-C	
	Genius (TC412)		PCR-96-2-NS		PCR-96-2-HS		PCR-8-200-C	PCR-2-C	
	Prime		PCR-96-2-NS		PCR-96-2-HS		PCR-8-200-C	PCR-2-C	
	Prime Elite		PCR-96-2-NS		PCR-96-2-HS		PCR-8-200-C	PCR-2-C	
	Prime Elite Satellite		PCR-96-2-NS		PCR-96-2-HS		PCR-8-200-C	PCR-2-C	
	PrimeG		PCR-96-2-NS		PCR-96-2-HS		PCR-8-200-C	PCR-2-C	
	Touchgene Gradient (TC512)		PCR-96-2-NS		PCR-96-2-HS		PCR-8-200-C	PCR-2-C	
	Touchgene X		PCR-96-2-NS		PCR-96-2-HS		PCR-8-200-C	PCR-2-C	
	PrimeQ		PCR-96-2-NS		PCR-96-2-HS		PCR-8-200-C	PCR-2-C	
	Quantica		PCR-96-2-NS		PCR-96-2-HS		PCR-8-200-C	PCR-2-C	
Roche	lightcycler 480 II	PCR-96-1-NS				PCR-8-100-C			
	lightcycler 96	PCR-96-1-NS				PCR-8-100-C			
	lightcycler nano	PCR-96-1-NS				PCR-8-100-C			



# Deep Well Plate & Magnetic Tip Comb

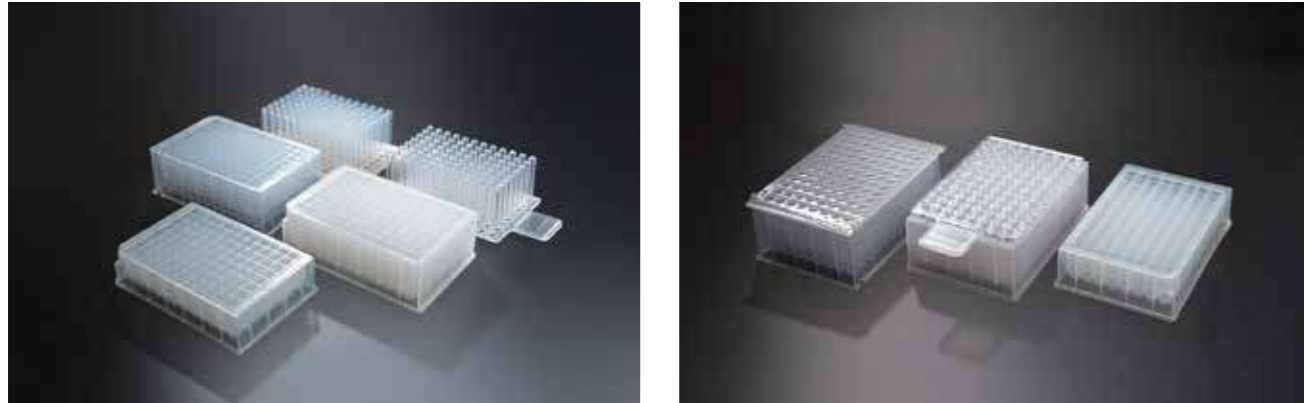

Our Deep Well Plate with a magnetic tipped comb is appropriate for extracting nucleic acids using specific models of nucleic acid extractor machines. In the process of conducting the nucleic acid extraction experiment, the protective magnetic rod is detached from the liquid. This separation helps prolong the lifespan of the magnetic rod.

## Product Features

- ▶ The surface height difference is within 0.1 mm to ensure no leakage when sealing
- ▶ Used for sample collection, in vitro chamber culture and long-term storage
- ▶ Made of highly transparent polypropylene (PP) material, resistant to alcohol and other mild organic solvents
- ▶ The protruding design of the square hole, the sealing performance is better after film coating, and it is not easy to leak
- ▶ U-shaped and V-shaped bottom design is suitable for sample mixing and collection
- ▶ Alphabetical sorting and cut corner marks make the preservation and collection of samples more convenient and quick
- ▶ Suitable for multi-channel pipettes and automation systems
- ▶ Certification: CE, FDA



## 96-Well Deep Well Plate

Cat. No.	Specification (mL)	Bottom Shape	Well Shape	Packaging	
				Pcs/Box	Boxes/Carton
DWP-96U16	1.6	U-shape	Square	20	4
DWP-96U22	2.2	U-shape	Square	16	4
DWP-96V22	2.2	V-shape	Square	16	4

## 96-Well Magnetic Tip Comb

Cat. No.	Specification (mL)	Bottom Shape	Well Shape	Packaging	
				Pcs/Box	Boxes/Carton
MTC-96V	2.0	V-shape	Round	32	4

\*Add suffix B after the Cat. No. for ordering the Bulk Pack.

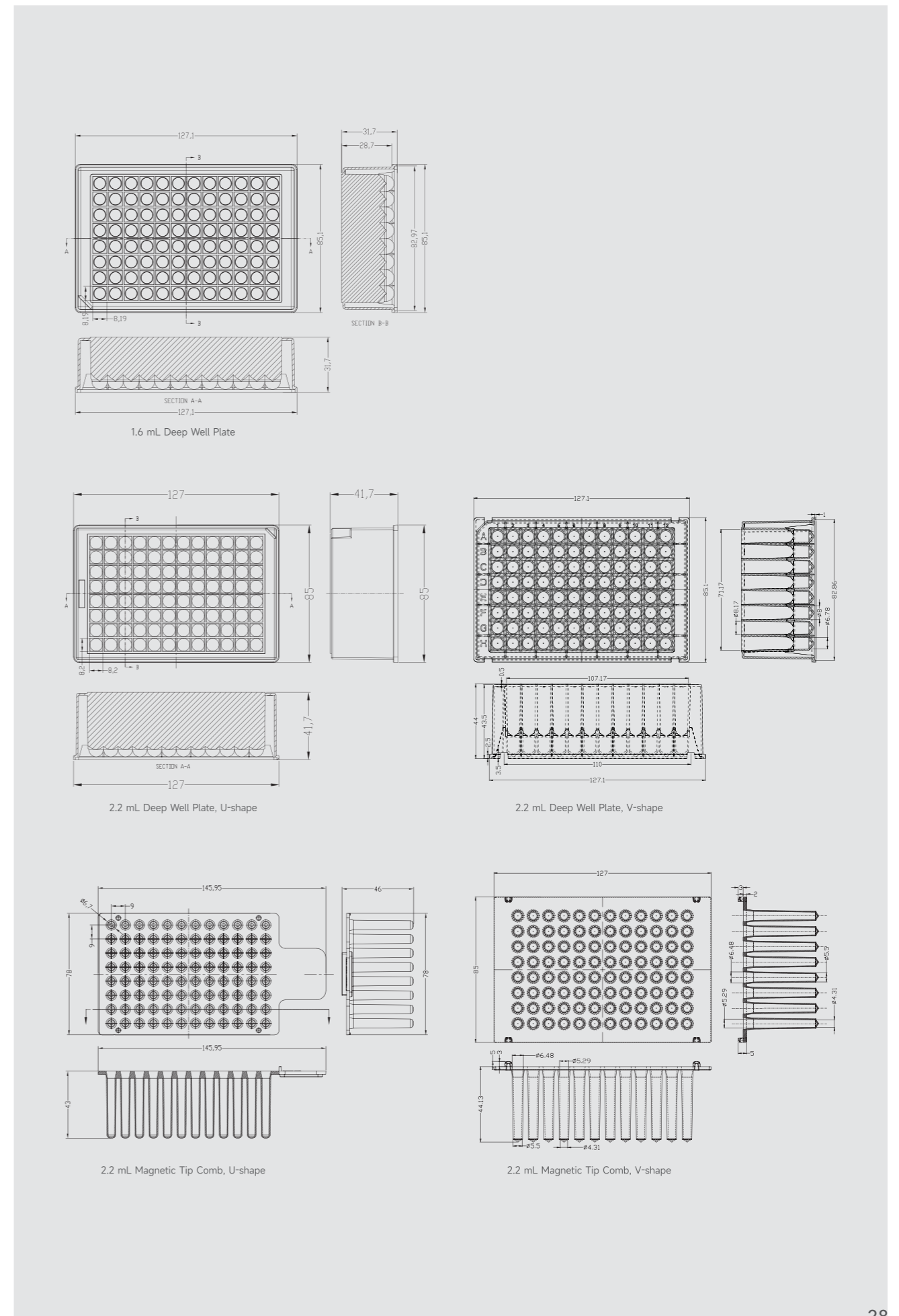

# STORAGE

---

Cryogenic Box

Cryogenic Vial

# Cryogenic Box and Cryogenic Vial



Plasticus offer a selection of cryogenic vials made from highly transparent PP material, which allows for efficient storage of samples at low temperatures. These vials are transparent, allowing for easy observation of the sample. The threaded cap and vertical design ensure easy handling. Additionally, the vials come with a large writing area and rounded bottom, facilitating easy pouring of liquids. The thick wall of the vial ensures that it will not break, even if the sample freezes and expands in an ultra-low temperature environment. The tubes are compact and can be used with our 81-Well cryogenic box.

## Features of Cryogenic Vial

- ▶ Material: Polypropylene (PP)
- ▶ Volume: 2 mL
- ▶ Type: External Screw Cap
- ▶ Color: Transparent
- ▶ Temperature Tolerance: -196°C
- ▶ Others: Sterile, DNase & RNase Free



## Cryogenic Vial

Cat. No.	Specification (mL)	Cap Color	Packaging	
			Pcs/Bag	Bags/Carton
CV-2-ET	2	White	50	40

## Features of Cryogenic Box

- ▶ L\*W\*H: 128.5\*128.5\*52 mm, Inner Hole 12.9\*12.9 mm
- ▶ Made of highly transparent polypropylene (PP) material, the samples can be repeatedly frozen and thawed and stored for a long time
- ▶ Temperature Tolerance: -80° C to 100° C
- ▶ Resistant to alcohol and other mild organic solvents
- ▶ Applicable to standard size cryogenic vials and cryogenic racks
- ▶ Suitable for storing 0.5 mL, 1 mL, 2 mL cryovials and 1.5 mL, 2.0 mL EP tubes



## Cryogenic Box

Cat. No.	Specification	Box Color	Packaging	
			Pcs/Box	Boxes/Carton
CB-81	81-Well	White	1	63

# BIOCHEMISTRY

ELISA Plate



# ELISA Plate

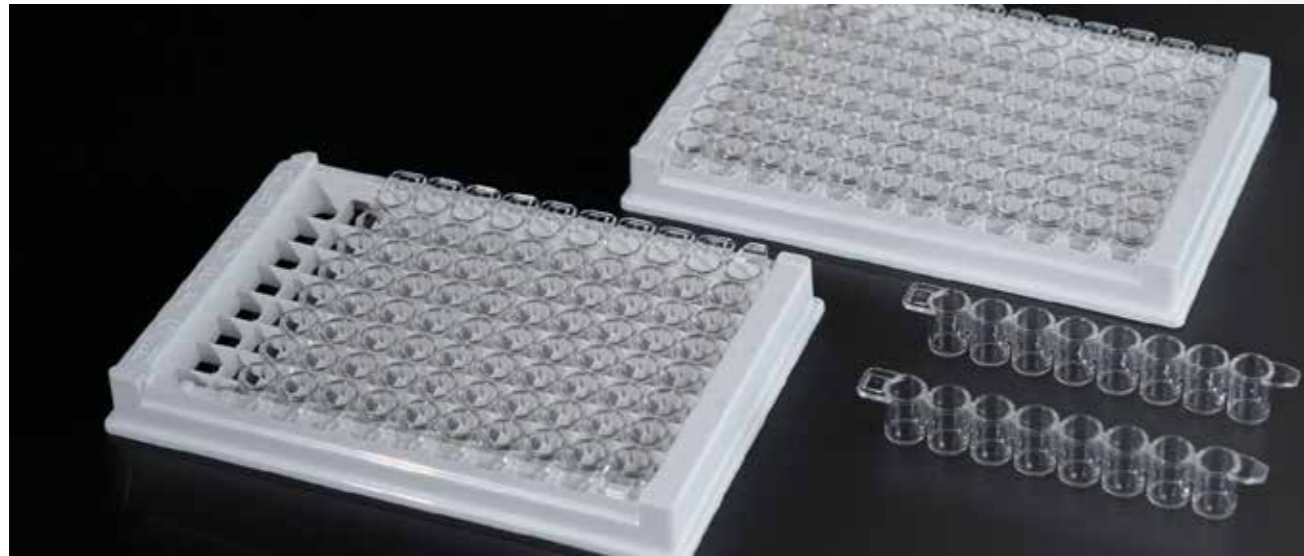

Our ELISA Plate surface is treated in a specific way, resulting in high protein adsorption effect of more than 600 ng/cm<sup>2</sup>. This plate is widely used in laboratory ELISA tests. The bottom of the plate is uniformly flat, with a low refractive index and high light transmission. This makes it convenient for the enzyme marker to detect signals from the bottom. The plate is designed with removable wells, with 8 wells per strip and a total of 12 strips. This design offers convenience, flexibility, and cost-effectiveness.

## Product Features

- ▶ Material: PS (Strips) + ABS (Rack)
- ▶ Protein Adsorption Effect: >600 ng/cm<sup>2</sup>
- ▶ Specification: 8-strip, 96-Well
- ▶ Bottom: Flat
- ▶ Aseptic Processing: Electron Beam
- ▶ Maximum Load Each Well: 300 μL
- ▶ Surface Treatment: Special treatment for high protein adsorption

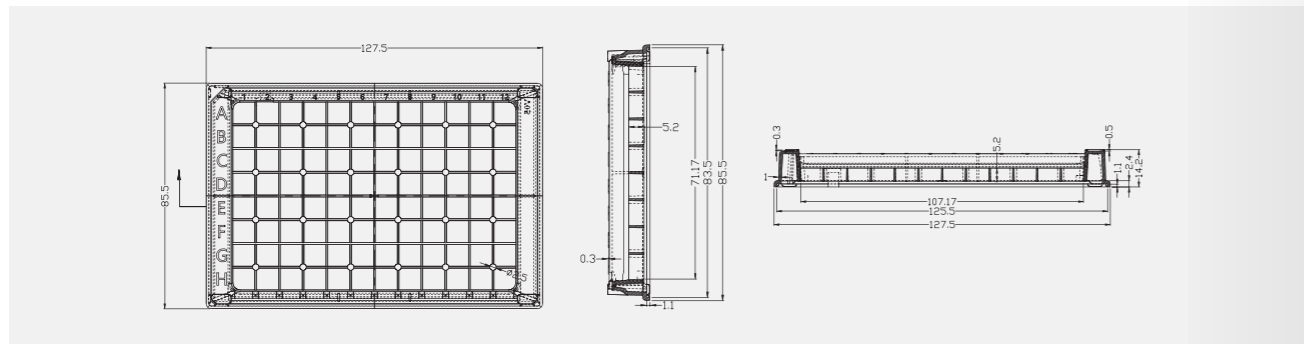

## Applications of ELISA Plates:

- ▶ Medical Diagnostics
- ▶ Biomedical Research
- ▶ Pharmaceutical Development
- ▶ Food Safety Testing
- ▶ Environmental Monitoring
- ▶ Veterinary Diagnostics

## Processes Involved in ELISA Assays:

- ▶ Coating
- ▶ Blocking
- ▶ Incubation
- ▶ Washing
- ▶ Detection
- ▶ Analysis

## Industries Utilizing ELISA Plates:

- ▶ Medical and Clinical Diagnostics
- ▶ Biotechnology and Pharmaceutical
- ▶ Food and Beverage
- ▶ Environmental Monitoring
- ▶ Veterinary and Animal Health

## ELISA Plate

Cat. No.	Surface Type	Specification (Well)	Packaging	
			Pcs/Box	Boxes/Carton
EPST-96-F	Special Treatment	8-Strip, 96-Well	10	20

\*Add suffix B after the Cat. No. for ordering the Bulk Pack.

# Our Presence



## YOUR SATISFACTION IS OUR PRIORITY

Microlit products follow GMP norms and are manufactured under comprehensive QA (Quality Assurance) & QC (Quality Control). Our products reflect the design philosophy of our organisation combining the best performance parameters with the best user experience. However, if you are dissatisfied with the operation of any of our products, get in touch with us or call your nearest Microlit dealer for free replacement. The HSN Code for Plasticus Consumables is 39269099.

## CONTACT US

### Microlit INDIA

629 Pakramau, Kursi Road, Lucknow 226026, India  
Phone: +91 9918625629, Email: [info@microlit.com](mailto:info@microlit.com)  
[www.microlit.com](http://www.microlit.com)

### Microlit LATAM

Business Place Ibirapuera, 9th Floor, Number 93,  
Alameda dos Jurupis 1005 - Moema,  
Indianópolis São Paulo, Brasil CEP - 04088-000,  
Phone: +55 11 93269-5932, Email: [info-latam@microlit.com](mailto:info-latam@microlit.com)

### Microlit USA

33 Wood Avenue South, Suite 600, Iselin, NJ 08830, USA  
Phone: +1 732 321 0852, Email: [info-usa@microlit.com](mailto:info-usa@microlit.com)  
[www.microlit.us](http://www.microlit.us)

## Follow us

